

PART No. 1414N4PHSSM6

Data subject to change without notice

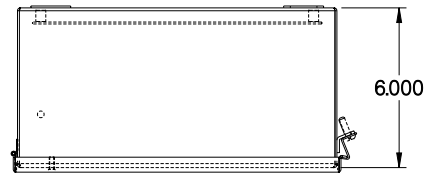

TOP VIEW

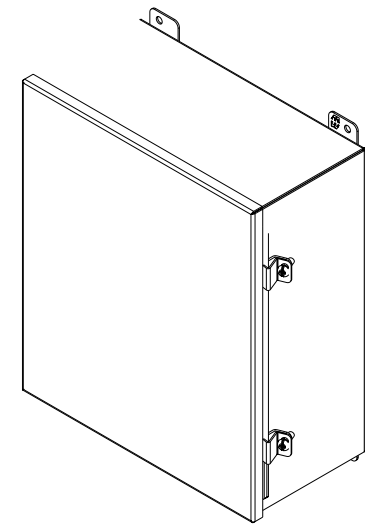

ISOMETRIC VIEW

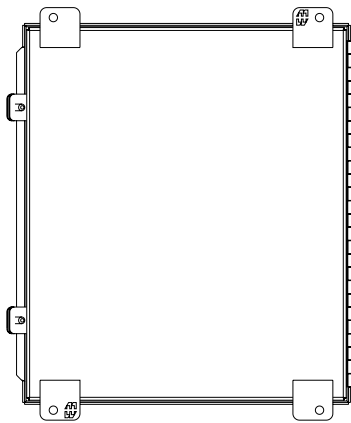

BACK VIEW

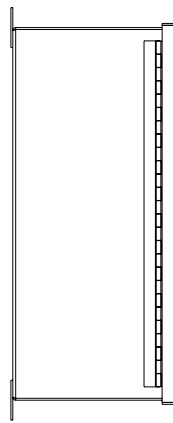

LEFT SIDE VIEW

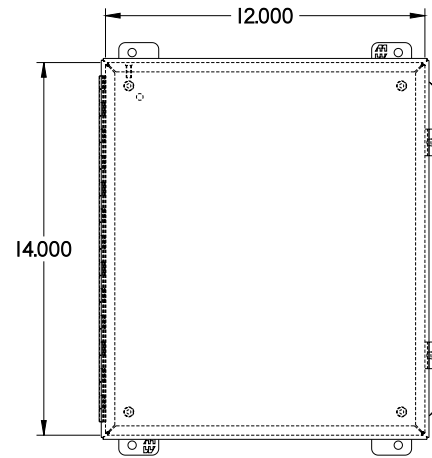

FRONT VIEW

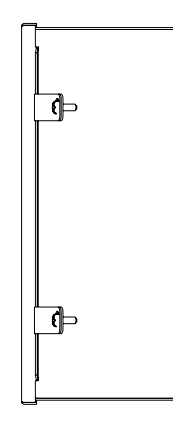

RIGHT SIDE VIEW

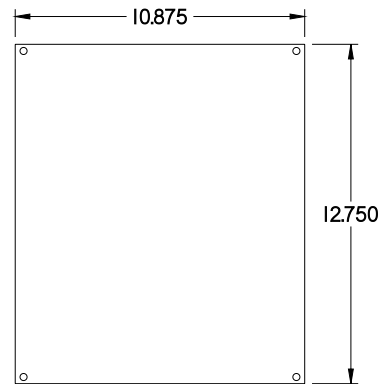

INNER PANEL

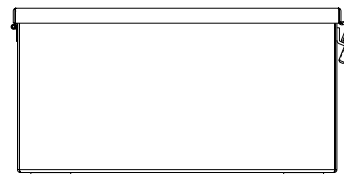

BOTTOM VIEW

